

PRODUCT DESCRIPTION

- Fixed output build in LED Driver.
- Constant Current LED Driver.
- Output Current 1700MA .
- Max Output Power 102W.
- Nominal Life-Time Upto 30,000 hr.
- 3-Year Warranty.
- High Voltage withstanding capacity 440V.



Input Characteristics

1	Voltage (Un)	240 Vac
2	Operating Voltage Range	100 ~300 Vac
3	Frequency (Hz)	50 / 60 Hz
4	Maximum Input Current	0.48 A
5	Input Power (W)	115W
6	Power Factor (PF)	> 0.98
7	Inrush current Protection	Yes
8	Current Harmonics (Athd)	< 10%
9	Surge Withstanding Capacity	4 KV
10	Over Voltage Cutoff	320V (Tole : +/-10V)
11	Automatic Restart	300V
12	Driver Life	>30000Hrs

Output Characteristics

Output short circuit protection and Restart	Yes
Over Current Protection	Yes
Thermal Protection	Yes
No-Load Protection	Yes
Max Output Current	1700MA (Tole : +/-3%)
Output Voltage	30V-60 V MAX
Output Power (W)	102W MAX
Efficiency	88%

Environmental Operating Details

1	Minimum Starting Temperature	-30°C ... 75°C
2	Max. Ambient Temperature	-30°C ... to 50°C
3	Max. Case temperature (Tc)	75°C

Key Features

- Compact Design
- High Voltage withstanding capacity
- High Surge withstanding capacity
- Long Life
- High Durability
- Automatic Restart after Safe Voltage Mode.

Metal Box

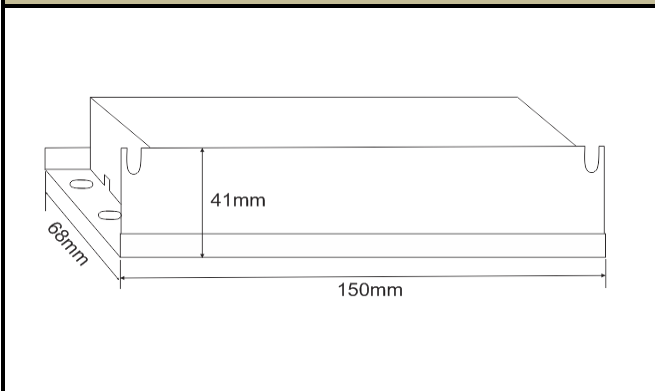

Mechanical Details

1 Weight	440gm
2 Case Dimensions	
Length W/Mount	184mm
Center to Center (CTC)	139mm
Width	85mm
Height	46mm
3 Case Material	Metal Box
4 Wiring Diagram	On Screen
5 Input / Output Terminals	NA
6 Wires Length	
Input (3 CORE)	300mm
Output (2 CORE)	300mm
7 Potting	YES IP-67

Bottom

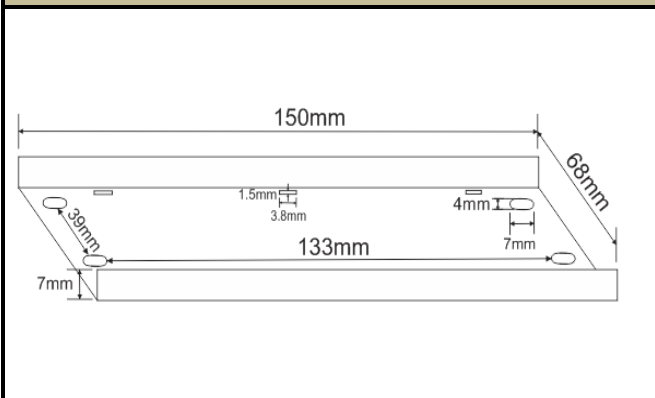

Top

