

PRODUCT DESCRIPTION

- Fixed output build in LED Driver.
- Constant Current LED Driver.
- Output Current 1400mA .
- Max Output Power 60W.
- Nominal Life-Time Upto 30,000 hr.
- 3-Year Warranty.
- High Voltage withstanding capacity 440V.

Input Characteristics

1	Voltage (Un)	240 Vac
2	Operating Voltage Range	100 ~300 Vac
3	Frequency (Hz)	50 / 60 Hz
4	Maximum Input Current	0.26A
5	Input Power (W)	70W
6	Power Factor (PF)	> 0.98
7	Inrush current Protection	Yes
8	Current Harmonics (Athd)	< 10%
9	Surge Withstanding Capacity	4KV
10	Over Voltage Cutoff	310V (Tole +/-10V)
11	Automatic Restart	300V
12	Driver Life	>30000Hrs

Output Characteristics

Output short circuit protection and Restart	Yes
Over Current Protection	Yes
Thermal Protection	Yes
No-Load Protection	Yes
Max Output Current	1400mA (Tole +/-3%)
Output Voltage	40V
Output Power (W)	70W max
Efficiency	88%

Environmental Operating Details

1	Minimum Starting Temperature	-30°C ... 85°C
2	Max. Ambient Temperature	-30°C ... to 50°C
3	Max. Case temperature (Tc)	85°C

Key Features

- Compact Design
- High Voltage withstanding capacity
- High Surge withstanding capacity
- Long Life
- High Durability
- Automatic Restart after Safe Voltage Mode.

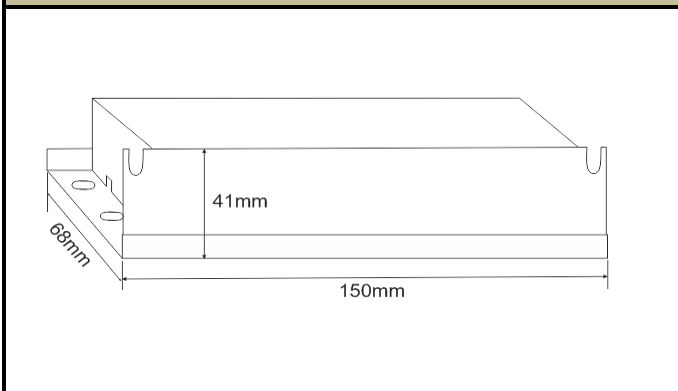
Metal Box

Mechanical Details

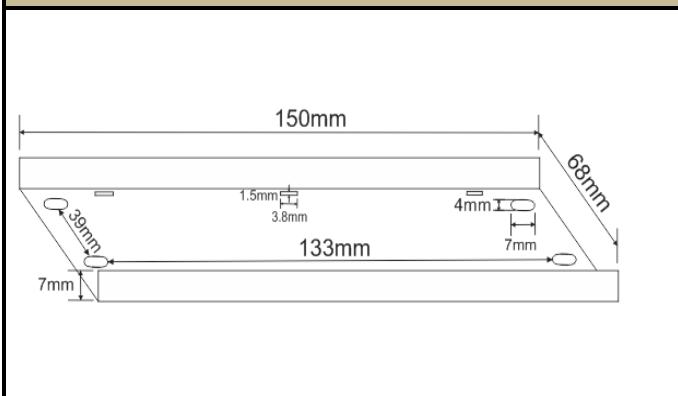
1 Weight	440gm
2 Case Dimensions	
Length W/Mount	150mm
Center to Center (CTC)	139mm
Width	68mm
Height	41mm
3 Case Material	Metal Box
4 Wiring Diagram	On Screen
5 Input / Output Terminals	NA
6 Wires Length	
Input (3 CORE)	300 mm
Output (2 CORE)	300 mm
7 Potting	YES

Bottom

Top
