



## PRODUCT DESCRIPTION

- Fixed output build in LED Driver.
- Constant Current LED Driver.
- Output Current 850mA .
- Max Output Power 68W.
- Nominal Life-Time Upto 30,000 hr.
- 3-Year Warranty.
- High Voltage withstanding capacity 440V.



### Input Characteristics

1	Voltage (Un)	240 Vac
2	Operating Voltage Range	100 ~300 Vac
3	Frequency (Hz)	50 / 60 Hz
4	Maximum Input Current	0.30A
5	Input Power (W)	75W
6	Power Factor (PF)	> 0.98
7	Inrush current Protection	Yes
8	Current Harmonics (Athd)	< 10%
9	Surge Withstanding Capacity	4KV
10	Over Voltage Cutoff	310V (Tole +/-10V)
11	Automatic Restart	300V
12	Driver Life	>30000Hrs

### Output Characteristics

Output short circuit protection and Restart	Yes
Over Current Protection	Yes
Thermal Protection	Yes
No-Load Protection	Yes
Max Output Current	850mA (Tole - +/-3%)
Output Voltage	80V
Output Power (W)	68W max
Efficiency	88%

### Environmental Operating Details

1	Minimum Starting Temperature	-30°C ... 85°C
2	Max. Ambient Temperature	-30°C ... to 50°C
3	Max. Case temperature (Tc)	85°C

### Key Features

- Compact Design
- High Voltage withstanding capacity
- High Surge withstanding capacity
- Long Life
- High Durability
- Automatic Restart after Safe Voltage Mode.

### Metal Box

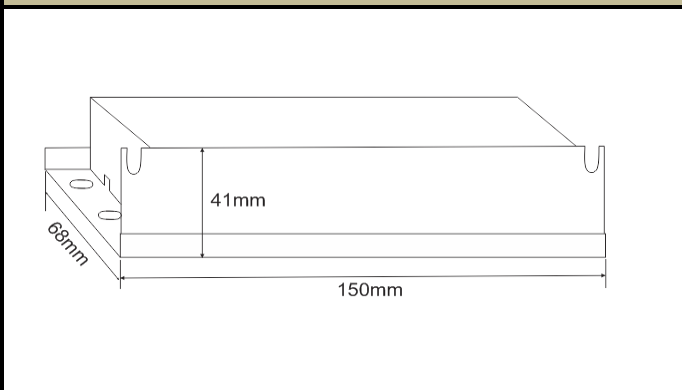

### Mechanical Details

1	Weight	440gm
2	Case Dimensions	
	Length W/Mount	150mm
	Center to Center (CTC)	139mm
	Width	68mm
	Height	41mm
3	Case Material	Metal Box
4	Wiring Diagram	On Screen
5	Input / Output Terminals	NA
6	Wires Length	
	Input (3 CORE)	300 mm
	Output (2 CORE)	300 mm
7	Potting	YES

### Bottom

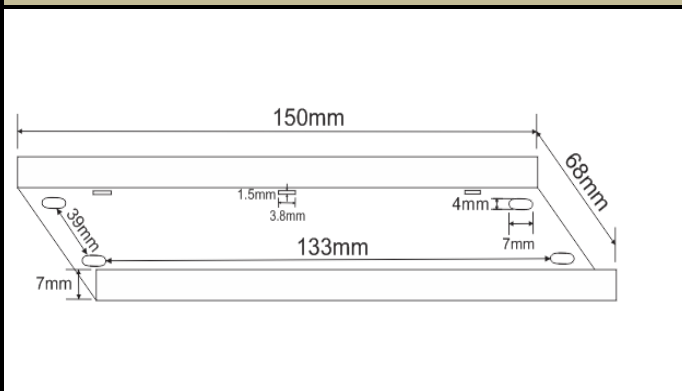

### Top

