

PRODUCT DESCRIPTION

- Fixed output build in LED Driver.
- Constant Current LED Driver.
- Output Current 700MA .
- Max Output Power 45W.
- Nominal Life-Time Upto 30,000 hr.
- 3-Year Warranty.
- High Voltage withstanding capacity 440V.

Input Characteristics

1	Voltage (Un)	240 Vac
2	Operating Voltage Range	100 ~300 Vac
3	Frequency (Hz)	50 / 60 Hz
4	Maximum Input Current	0.2A
5	Input Power (W)	50W
6	Power Factor (PF)	> 0.98
7	Inrush current Protection	Yes
8	Current Harmonics (Athd)	< 10%
9	Surge Withstanding Capacity	4KV
10	Over Voltage Cutoff	320V (Tole - +/-10V)
11	Automatic Restart	300V
12	Driver Life	>30000Hrs

Output Characteristics

Output short circuit protection and Restart	Yes
Over Current Protection	Yes
Thermal Protection	Yes
No-Load Protection	Yes
Max Output Current	700mA (Tole - +/-3%)
Output Voltage	63V
Output Power (W)	45W max
Efficiency	88%

Environmental Operating Details

1	Minimum Starting Temperature	-30°C ... 75°C
2	Max. Ambient Temperature	-30°C ... to 50°C
3	Max. Case temperature (Tc)	75°C

Key Features

- Compact Design
- High Voltage withstanding capacity
- High Surge withstanding capacity
- Long Life
- High Durability
- IP 65
- Automatic Restart after Safe Voltage Mode.

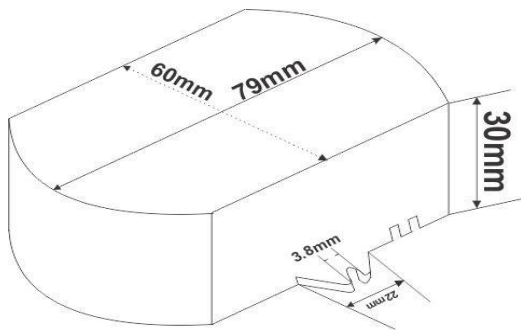
PLASTIC BOX

Mechanical Details

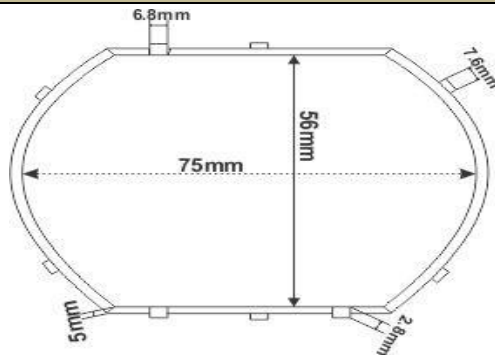
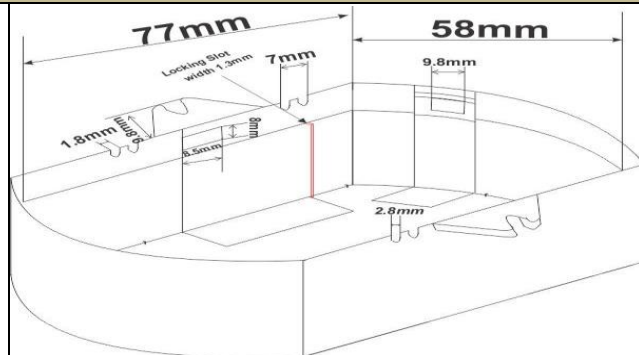
1 Weight	90 gm
2 Case Dimensions	
Length W/Mount	80mm
Center to Center (CTC)	75mm
Width	80mm
Height	31mm
3 Case Material	PC
4 Wiring Diagram	On Screen
5 Input / Output Terminals	Connector
6 Wires Length & Colors	
Input (Yellow)	NA
Output (Red & Black)	NA
7 Potting	Yes IP-67

BOTTOM

TOP

IS15885 (PART2/SEC13) R-71000183

Add:-SR.NO. 14, Dhadge ind Estate, plot no.3 Singhgad Road, Nanded Phata, Pune-411041, Maharashtra(India)

Email : marketing@hrindustry.net

harish@hrindustry.net
support@hrindustry.net

web : www.hrindustry.net

contact no. : +91 9049378851 , 020 65209702,8668334832