



TECHNICAL DATA SHEET : LED DRIVER CONSTANT CURRENT

Model No : HR0550MA080VBMS



PRODUCT DESCRIPTION

- Fixed output build in LED Driver.
- Constant Current LED Driver.
- Output Current 550 mA .
- Max Output Power 44 W.
- Nominal Life-Time Upto 30,000 hr.
- 3-Year Warranty.
- High Voltage withstanding capacity 440V.



Input Characteristics

1	Voltage (Un)	240 Vac
2	Operating Voltage Range	100 ~300 Vac
3	Frequency (Hz)	50 / 60 Hz
4	Maximum Input Current	0.2 A
5	Input Power (W)	49 W
6	Power Factor (PF)	> 0.99
7	Inrush current Protection	Yes
8	Current Harmonics (Athd)	< 10%
9	Surge Withstanding Capacity	4 KV
10	Over Voltage Cutoff	320V (Tole : +/- 10V)
11	Automatic Restart	310V
12	Driver Life	>30000Hrs

Output Characteristics

Output short circuit protection and Restart	Yes
Over Current Protection	Yes
Thermal Protection	Yes
No-Load Protection	Yes
Max Output Current	550 mA (Tole : +/-3%)
Output Voltage	80 V
Output Power (W)	44 W max
Efficiency	89%

Environmental Operating Details

1	Minimum Starting Temperature	-30°C ... 75°C
2	Max. Ambient Temperature	-30°C ... to 50°C
3	Max. Case temperature (Tc)	75°C

Key Features

- Compact Design
- High Voltage withstanding capacity
- High Surge withstanding capacity
- Long Life
- High Durability
- Automatic Restart after Safe Voltage Mode.

Metal Box

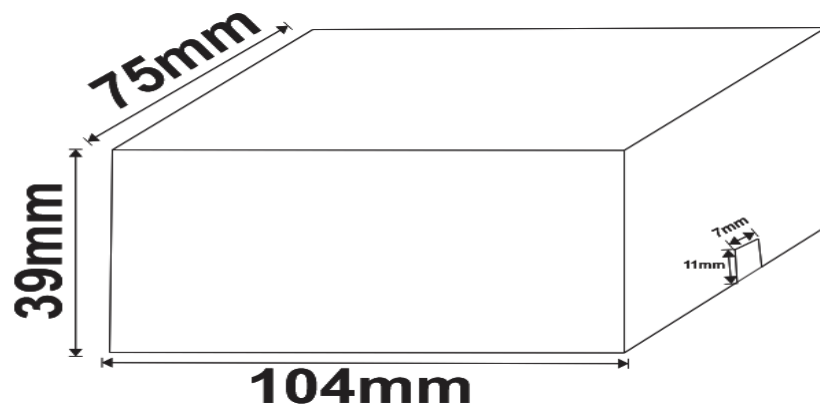

Mechanical Details

1	Weight	250gm
2	Case Dimensions	
	Length W/Mount	104mm
	Center to Center (CTC)	-
	Width	75mm
	Height	39mm
3	Case Material	Metal Box
4	Wiring Diagram	On Screen
5	Input / Output Terminals	Connector
6	Wires Length & Colors	
	Input (Yellow)	NA
	Output (Red & Black)	NA
7	Potting	NA

Bottom

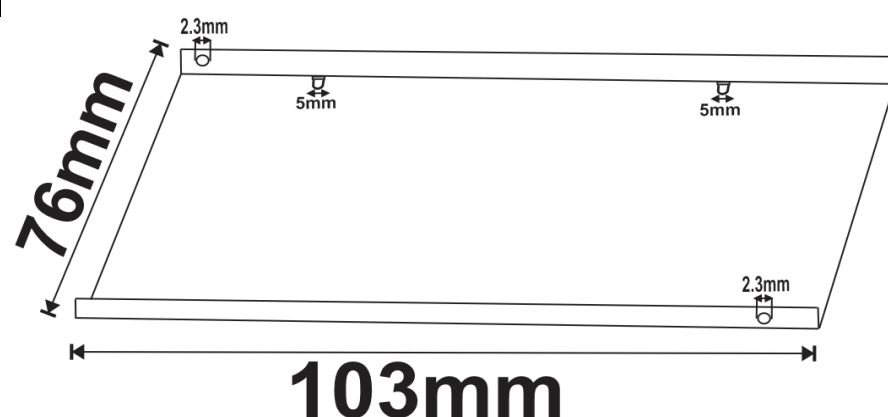

Top

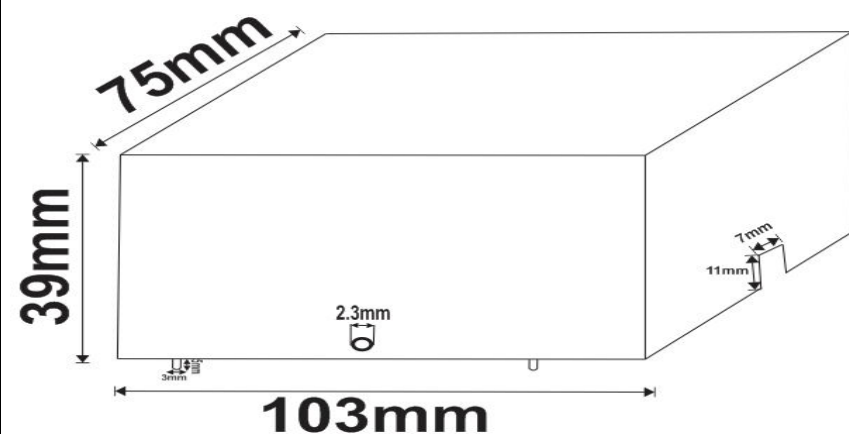

Add:-SR.NO. 14, Dhadge ind Estate, plot no.3 Singhgad Road, Nanded Phata, Pune-411041, Maharashtra(India)

Email : marketing@hrindustry.net

harish@hrindustry.net

support@hrindustry.net

web : www.hrindustry.net

contact no. : +91 9049378851 , 020 65209702