



PRODUCT DESCRIPTION

- Fixed output build in LED Driver.
- Constant Current LED Driver.
- Output Current 220mA .
- Max Output Power 10W.
- Nominal Life-Time Upto 30,000 hr.
- 3-Year Warranty.
- High Voltage withstanding capacity 300V.



Input Characteristics

1	Voltage (Un)	240 Vac
2	Operating Voltage Range	100 ~300 Vac
3	Frequency (Hz)	50 / 60 Hz
4	Maximum Input Current	0.049A
5	Input Power (W)	12W max
6	Power Factor (PF)	> 0.97
7	Inrush current Protection	Yes
8	Current Harmonics (Athd)	< 20%
9	Surge Withstanding Capacity	3KV
10	Driver Life	>30000Hrs

Output Characteristics

Over Current Protection	Yes
Thermal Protection	Yes
No-Load Protection	Yes
Max Output Current	250mA (Tole +/-3%)
Output Voltage	40V
Output Power (W)	10W max
Efficiency	85%

Environmental Operating Details

1	Minimum Starting Temperature	-30°C ... 70°C
2	Max. Ambient Temperature	-30°C ... to 50°C
3	Max. Case temperature (Tc)	70°C

Key Features

- Compact Design
- High Voltage withstanding capacity
- High Surge withstanding capacity
- Long Life
- High Durability

PLASTIC BOX

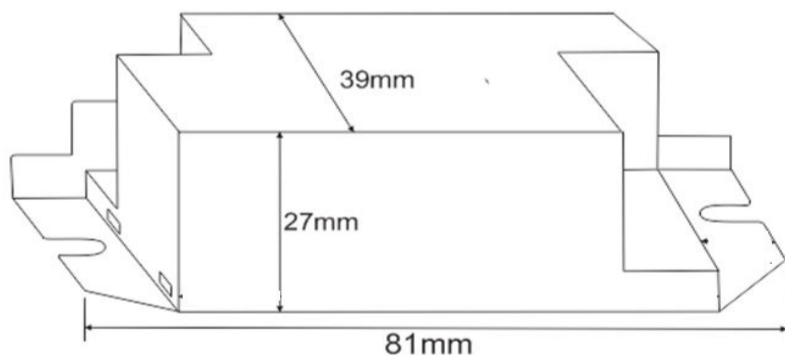

Mechanical Details

1	Weight	40gm
2	Case Dimensions	
	Length W/Mount	81mm
	Center to Center (CTC)	75mm
	Width	39mm
	Height	27mm
3	Case Material	PC
4	Wiring Diagram	On Screen
5	Input / Output Terminals	Connector
6	Wires Length & Colors	
	Input (Yellow)	NA
	Output (Red & Black)	NA
7	Potting	NA

BOTTOM

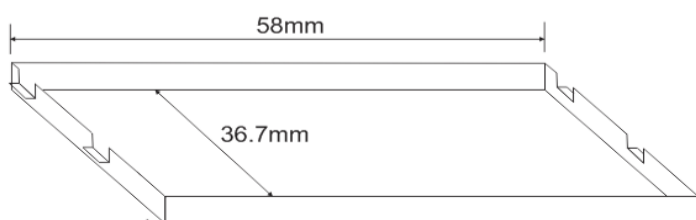

TOP

